

Varenummer: 2031100M16200B4T  
 Beskrivelse: E+G Justerfod  
 GN 31-100-M16-200-B4-T  
 Note: T Uden møtrik, spændeflade i bunden

## Mål

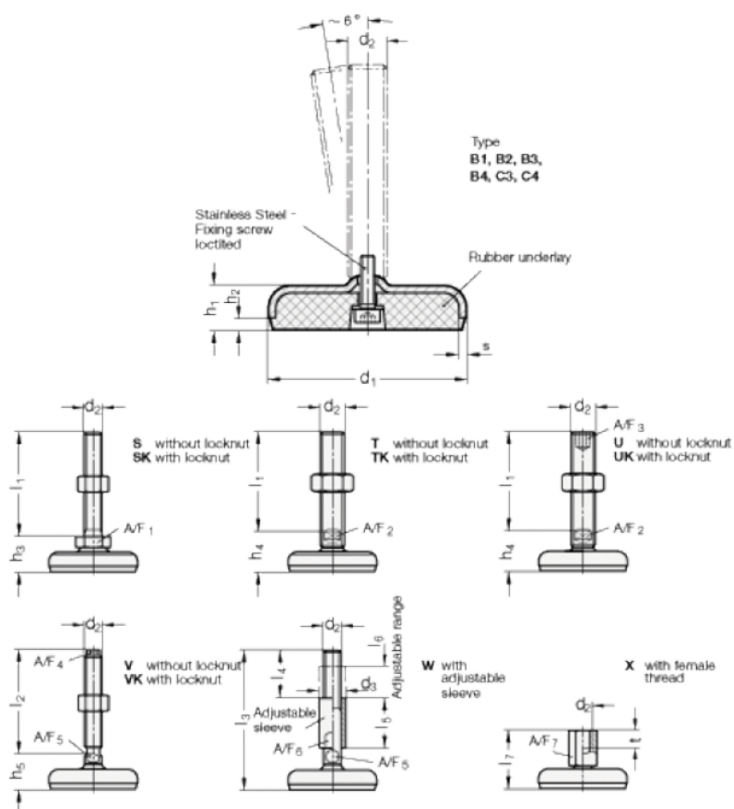

A/F2	= 12
d1	= 100
d2	= 16
h1	= 20
h2	= 6
h4 +4.0/0	= 34
l1	= 200
s	= 3